

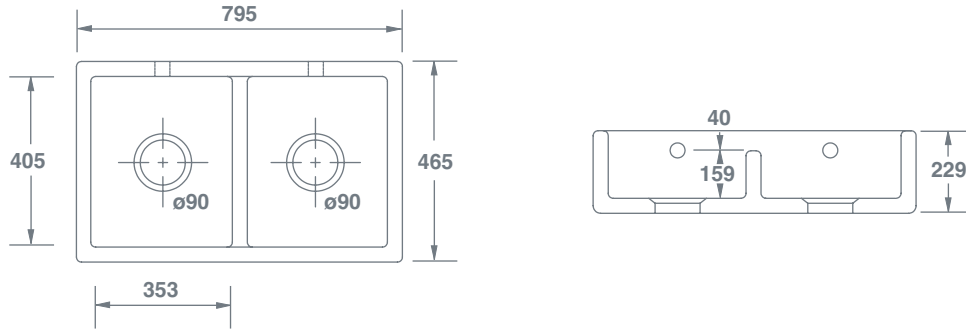





Shaker Double 800



		Dimensions / Abmessungen / Dimensions Dimensiones / Dimensioni					 KG
 Shaker Double 800 White Weiß / Blanc / Blanco / Bianco	SCSH800WH	(mm)	795	465	229	90	60.5
 Shaker Double 800 Biscuit Biskuit / Biscuit / Beige / Biscotto	SCSH800PN	(mm)	795	465	229	90	60.5
 Shaker Double 800 Matt Grey Mattgrau / Gris mat / Gris mate / Grigio opaco	SCSH800MG	(mm)	795	465	229	90	60.5
 Shaker Double 800 Matt Black Matt Schwarz / Noir mat / Negro mate / Nero opaco	SCSH800MB	(mm)	795	465	229	90	60.5



PLEASE NOTE, our sink dimensions can vary by a plus or minus of 2%, as they are hand-made and shrink during firing.

BITTE BEACHTEN SIE BITTE, dass die Abmessungen unserer Spülbecken um ca. 2% variieren können, da sie handgefertigt sind und beim Brennen schrumpfen.

ATTENTION, les dimensions de nos éviers peuvent varier de plus ou moins 2%, car ils sont fabriqués à la main et rétrécissent pendant la cuisson.

TENGA EN CUENTA que las dimensiones de nuestros fregaderos pueden variar en más o menos un 2%, ya que están hechos a mano y se encogen durante la cocción.

SI PREGA DI NOTARE che le dimensioni del nostro lavello possono variare di un più o meno del 2%, in quanto sono fatti a mano e si restringono durante la cottura.

Features include: Double bowl sink with dropped central dividing wall. Central 90mm waste outlets suitable for basket strainers or waste disposers. Round overflows.

Funktionen umfassen: Doppelspülbecken mit abgesenkter zentraler Trennwand. Zentrale 90mm Abläufe, geeignet für Siebkorb. Runde Überläufe.

Caractéristiques: Évier 2 bacs avec cloison centrale abaissée. Trous d'évacuation de 90mm adapté aux bodes à panier. Trop-pleins ronds.

Características: Fregadero de 2 cubetas con pared divisoria central más baja. Agujero desagüe de 90mm compatible con válvulas con cesta. Rebosaderos redondos.

Le caratteristiche includono: Lavello a doppia vasca con parete divisoria centrale a caduta. Bocchette di scarico centrali da 90mm adatte per filtri a cestello o tritarifiuti. Troppopieni rotondi.