

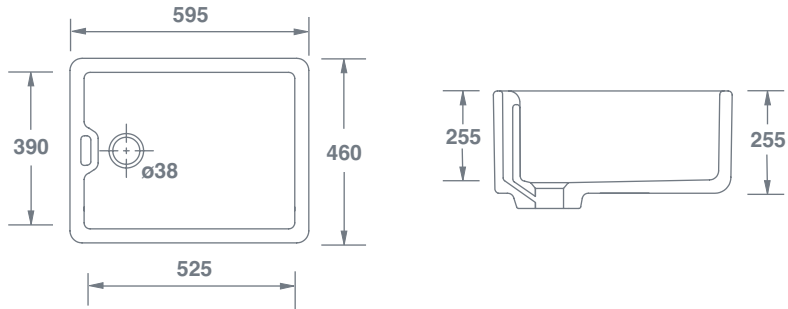





Belfast



		Dimensions / Abmessungen / Dimensions Dimensiones / Dimensioni					
 Belfast White Weiß / Blanc / Blanco / Bianco	SCBE600WH	(mm)	595	460	255	38	50
 Belfast Biscuit Biskuit / Biscuit / Beige / Biscotto	SCBE600PN	(mm)	595	460	255	38	50
 Belfast Matt Grey Mattgrau / Gris mat / Gris mate / Grigio opaco	SCBE600MG	(mm)	595	460	255	38	50
 Belfast Matt Black Matt Schwarz / Noir mat / Negro mate / Nero opaco	SCBE600MB	(mm)	595	460	255	38	50



PLEASE NOTE, our sink dimensions can vary by a plus or minus of 2%, as they are hand-made and shrink during firing.

BITTE BEACHTEN SIE BITTE, dass die Abmessungen unserer Spülbecken um ca. 2% variieren können, da sie handgefertigt sind und beim Brennen schrumpfen.

ATTENTION, les dimensions de nos éviers peuvent varier de plus ou moins 2%, car ils sont fabriqués à la main et rétrécissent pendant la cuisson.

TENGA EN CUENTA que las dimensiones de nuestros fregaderos pueden variar en más o menos un 2%, ya que están hechos a mano y se encogen durante la cocción.

SI PREGA DI NOTARE che le dimensioni del nostro lavello possono variare di un più o meno del 2%, in quanto sono fatti a mano e si restringono durante la cottura.

Features include: 38mm waste outlet to accommodate slotted waste or a 38mm basket strainer. Traditional Weir overflow.

Funktionen umfassen: 38mm Ablauf geeignet für Stopfen und Kette oder ein 38mm Siebkorbs. Integrierter Überlauf.

Caractéristiques: Évier 1 bac. Trou d'évacuation de 38 mm adapté aux bondes à panier ou aux bondes à chaînette avec trop-pleins. Trop-plein type déversoir.

Características: Fregadero de 1 cubeta. Agujero desagüe de 38mm. Compatible con válvulas con cesta o válvulas con rebosadero con tapón y cadena. Rebosadero tipo aliviadero

Le caratteristiche includono: Uscita per rifiuti da 38mm adatta per scarico a fessura/dado e catena o un filtro a cestino da 38mm. Tradizionale troppopieno a strabocco.